

Flat Cable Connector System

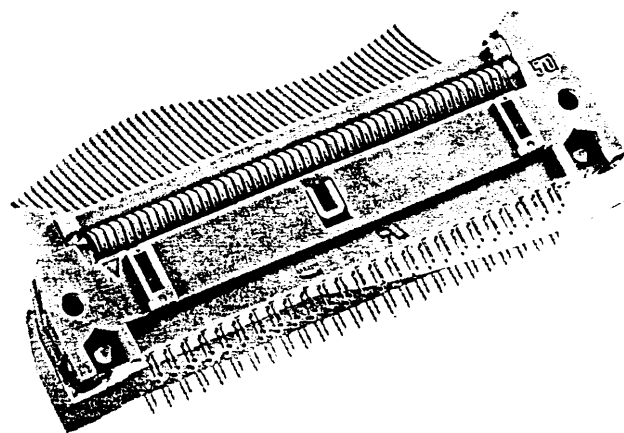

The best connections world-wide - connect with quality - specify HARTING

HARTING Elektronik GmbH was founded in 1945 and is 100 % privately owned.

Approximately 1,600 people are employed worldwide including 150 engineers and more than 100 sales engineers who provide the daily interface with our customers.

HARTING with its 15 subsidiaries in Europe, North America and Asia is today one of the world's leading connector manufacturers.

All the company's manufacturing plants, with the exception of Plant 1 in Espelkamp, have been built within the last ten years.

State of the art CAD-Systems are used both in the R & D department and the tool making department in order to bring new products to the market in the most efficient way.

It is HARTING's philosophy that the target of permanent zero defect production is only achievable by the integration of fully automatic in-line inspection processes.

The implementation of the above quality philosophy and associated processes are documented according to DIN ISO 9001 in the Quality Assurance Manual.

In total approximately 60 quality control personnel are employed. The majority of these engineers and technicians are trained and certified by the German (DCQ) or Swiss (SAQ) quality organisations. The divisions electronic connectors, heavy duty connectors Han® and solenoids are certified according to DIN ISO 9001 for design/R & D, production, assembly and customer service.

The dedication to quality and the ability to deliver on a "Just in Time" basis have led to the development of strong relationships with leading original equipment manufacturers on the world market.

HARTING is the market leader in several of its product ranges.

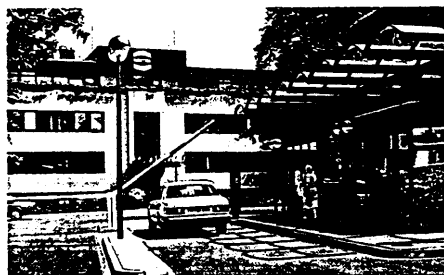

Germany - Plant 1 Espelkamp

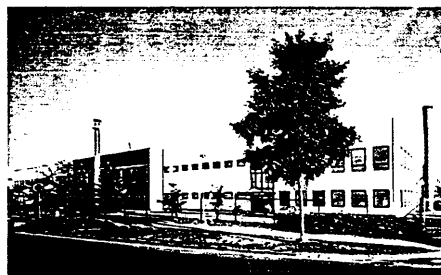

Germany - Plant 2 Espelkamp



Germany - Plant 3 Espelkamp



France - Sales and marketing



Espelkamp - Staff Cafeteria



United Kingdom - Production, sales and marketing

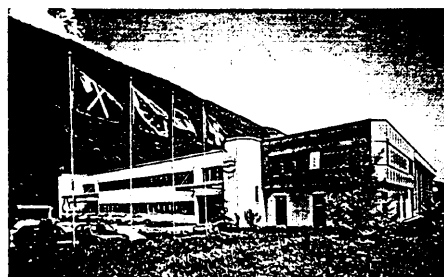







Switzerland - Production plant

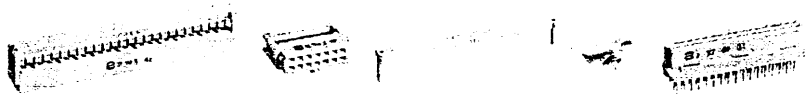
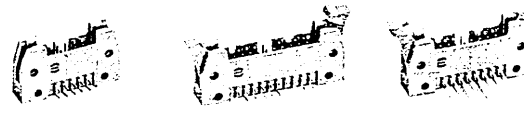
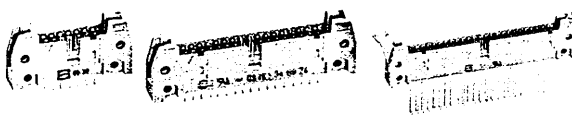
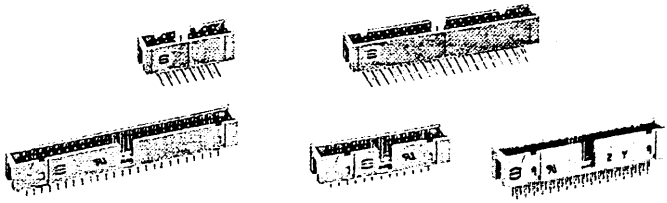
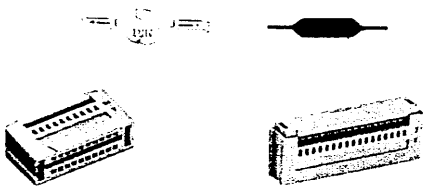

Hong Kong - Production, sales and marketing

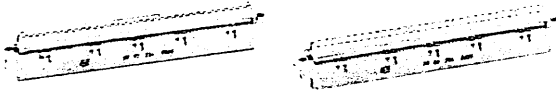
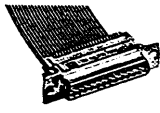

Italy - Sales and marketing

Series	Number of contacts		Page
Technical characteristics		Flat cable connector systems with insulation displacement	5
SEK 18/24			6
Male and female connectors to IEC	5		8
DIN 41 651	10		
MIL-C 83 503	14		
D 2632, BT 224	16		
HE 10, NFC 93-428	20		
	26		
UL/CSA-approved	33		10
	40		
	50		
	60		
	63		
Press-in tools / Accessories			12
			13
Card edge connectors for P.C.B. 1.6 mm	10 34		14
	16 50		16
	20 60		
	26 64		
SEK 18 solder transition connectors, 2 rows	6 34		17
	10 40		
	14 50		
	16 60		
	20 64		
SEK 17 DIP connectors	14 28		18
	16 40		
SEK 19 solder transition connectors, 4 rows	10 34		19
	16 40		
	20 50		
	26		
Gds A-B · Gds A-C Female connectors to DIN 41 612	64		20
D-Sub Subminiature connectors to DIN 41 652	9		21
	15		
	25		
	37		
Flat cable/ Tools for termination of flat cables			22
List of part numbers			25
Some of the components from the HARTING range			26
Addresses			27

The HARTING Insulation Displacement Technique



Economic and Reliable Connections

The flat cable and connector can be preassembled and used as a component with predetermined functional characteristics.

The HARTING insulation displacement contacts pierce the insulation on the flat cable to provide a durable gastight connection with the wire.

The HARTING[®] insulation displacement technique constitutes the ideal solution to your wiring problems.

[®]The HARTING insulation displacement system meets all the characteristics, specifications and test conditions of DIN 41 611/part 6.

For "non standard applications" we can manufacture designs to match your requirements. Please discuss requirements with us.

HARTING SEK connectors incorporate the latest design features and provide the assurance of high quality and reliability with economy.

Sales Department
HARTING-Components

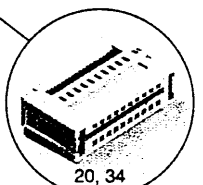
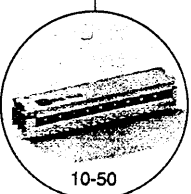
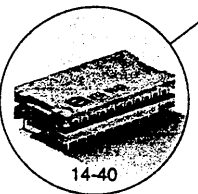
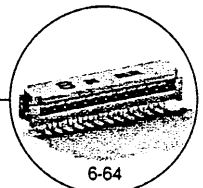
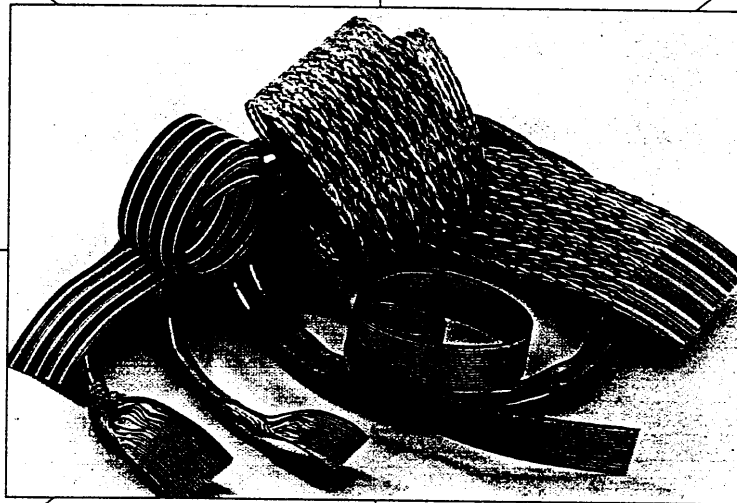
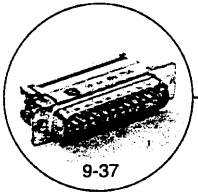
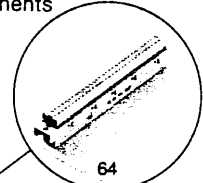
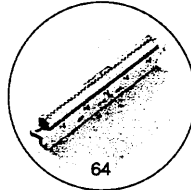
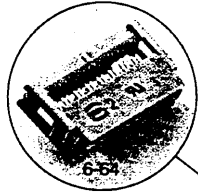

Cable assemblies

- HARTING can supply cable assemblies to customer specifications.
- A wide range of connector types available with various contact arrangements constitute the ideal solution to your wiring problems.
- Cables of all types in economic reel lengths are available.

Quality

- Cables professionally assembled on HARTING work stations ensure reliable connections.
- Finished harnesses are subject to 100% quality checks on a HARTING test device.
- 1 kV insulation test.
- Contact resistance test.

Economy

- The tested assembly of connectors and flat cables from one manufacturer guarantees a high degree of economy and reliability.
- Investment for work stations and test devices are not required.
- Stocks of piece parts are reduced.

General Information

It is the user's responsibility to check whether the components illustrated in this catalogue comply with different regulations from those stated in special fields of application which we are unable to foresee.

We reserve the right to modify designs in order to improve quality, keep pace with technological advancement or meet particular requirements in production.

This catalogue must not be used in any form or manner without our prior approval in writing (Copyright Law, Fair Trading Law, Civil Code).
We are bound by the French version only.

Technical Characteristics



Number of contacts 6, 9, 10, 14, 15, 16, 20, 24, 25, 26, 28, 34, 37, 40, 50, 60, 64
Series SEK 18
UL/CSA-approved

Pitch (mm)

Male header 2.54 mm

Insulation displacement contacts on the flat cable connector 1.27 mm

Working current 1 A

Test voltage $U_{r.m.s.}$ 1 kV
SEK 17, SEK 19: 500 V

Contact resistance $\leq 20 \text{ m}\Omega$

Insulation resistance $\geq 10^9 \Omega$

Temperature range $-55^\circ\text{C} + 125^\circ\text{C}$

The maximum temperature includes heating of contacts and ambient temperature.

Terminations

SEK 18 female connector transition connector Insulation displacement connection
Wire AWG 28 (7 x 0.127) 0.09 mm²

SEK 18 male header Wrap posts 0.6 x 0.6 mm
Diagonal 0.79-0.86 mm
Solder pins for P.C.B. hole \varnothing 0.9 mm, DIN IEC 52 141

SEK 18 Card edge Compliant press-in termination for \varnothing 0.94 - 1.06 mm
Insulation displacement connection
Wire AWG 28 (7 x 0.127) 0.09 mm²

SEK 17 and 19 Insulation displacement connection
Wire AWG 28 (7 x 0.127) 0.09 mm²

Gds A-B · Gds A-C Solder pins 0.45 x 0.35 mm for P.C.B. hole \varnothing 0.8 mm
D-Sub Insulation displacement connection
Wire AWG 28 (7 x 0.127) 0.09 mm²

Mouldings Thermoplastic resin (PBTP)
UL 94-V 0

Contact surface

SEK 18 Contact zone: gold-plated according to Performance Level¹⁾
Termination zone: tinned

SEK 17 and 19 Tinned

Gds A-B · Gds A-C Contact zone: gold-plated according to Performance Level¹⁾
D-Sub Termination zone: tinned

¹⁾Performance Level 3 as per DIN 41 651, Part 2
50 mating cycles
No gas test

¹⁾Performance Level 2 as per DIN 41 651, Part 2
200 mating cycles
4 days gas test

¹⁾Performance Level as per MIL-C 83 503
> 0.76 μm Au (30 μ inch) on request
Different contact surfaces on request

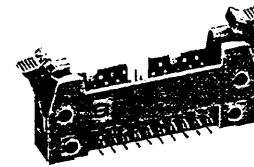

SEK 18

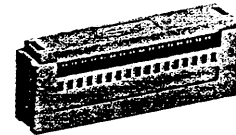
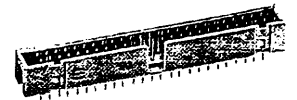

SEK 18

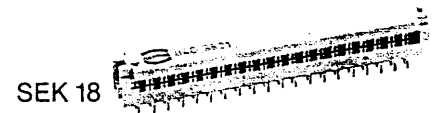

SEK 18

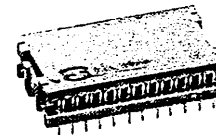

SEK 17



SEK 19



Gds A-B

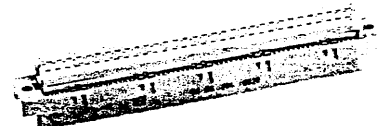

Gds A-C

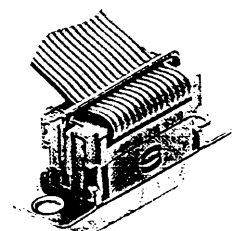





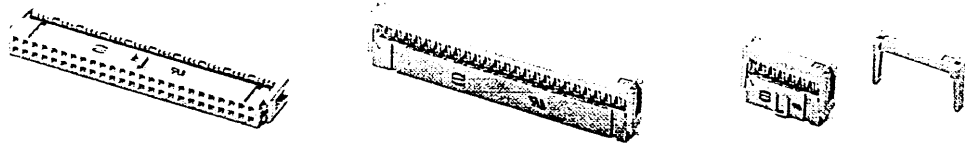

D-Sub

Number of contacts

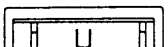
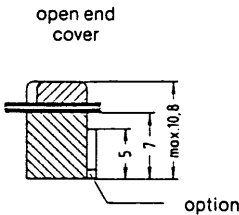
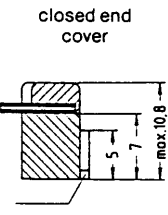
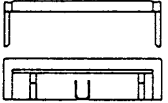
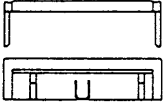
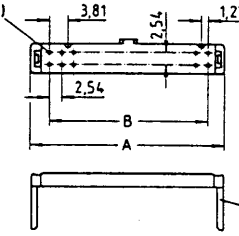
6-64

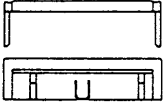
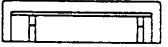
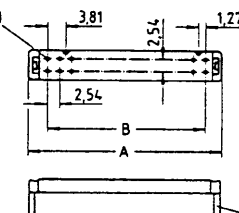

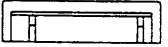
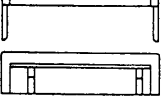
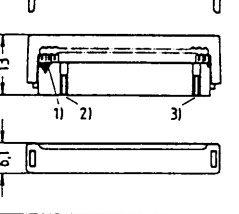
Female connector

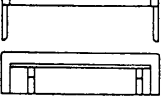
Identification	No. of contacts	Part No.		Drawing	Dimensions in mm			
		open end cover	closed end cover					
Female connector with central polarization without strain relief clamp 	6	09 18 506	803 09 18 506 804	  option				
	10	09 18 510	803 09 18 510 804					
	14	09 18 514	803 09 18 514 804					
	16	09 18 516	803 09 18 516 804					
	20	09 18 520	803 09 18 520 804					
	26	09 18 526	803 09 18 526 804					
	34	09 18 534	803 09 18 534 804					
	40	09 18 540	803 09 18 540 804					
	50	09 18 550	803 09 18 550 804					
	60	09 18 560	803 09 18 560 804					
	64	09 18 564	803 09 18 564 804					
	with strain relief clamp 	6	09 18 506			813 09 18 506 814*	  Strain relief clamp option	
		10	09 18 510			813 09 18 510 814*		
		14	09 18 514			813 09 18 514 814*		
		16	09 18 516			813 09 18 516 814*		
		20	09 18 520			813 09 18 520 814*		
26		09 18 526	813 09 18 526 814*					
34		09 18 534	813 09 18 534 814*					
40		09 18 540	813 09 18 540 814*					
50		09 18 550	813 09 18 550 814*					
60		09 18 560	813 09 18 560 814*					
64		09 18 564	813 09 18 564 814*					
Female connector without central polarization without strain relief clamp 		10	09 18 510	805 09 18 510 806*	  Strain relief clamp option			
		14	09 18 514	805 09 18 514 806*				
		16	09 18 516	805 09 18 516 806*				
		20	09 18 520	805 09 18 520 806*				
		26	09 18 526	805 09 18 526 806*				
	34	09 18 534	805 09 18 534 806*					
	40	09 18 540	805 09 18 540 806*					
	50	09 18 550	805 09 18 550 806*					
	60	09 18 560	805 09 18 560 806*					
	64	09 18 564	805 09 18 564 806*					
	with strain relief clamp 	10	09 18 510	815* 09 18 510 816*			  Strain relief clamp option	
		14	09 18 514	815* 09 18 514 816*				
		16	09 18 516	815* 09 18 516 816*				
		20	09 18 520	815* 09 18 520 816*				
		26	09 18 526	815* 09 18 526 816*				
		34	09 18 534	815* 09 18 534 816*				
40		09 18 540	815* 09 18 540 816*					
50		09 18 550	815* 09 18 550 816*					
60		09 18 560	815* 09 18 560 816*					
64		09 18 564	815* 09 18 564 816*					

No. of contacts	6	10	14	16	20	26	34	40	50	60	64
A	12,2	17,3	22,4	24,9	30,0	37,6	47,8	55,4	68,1	80,8	85,9
B	5,08	10,16	15,24	17,78	22,86	30,48	40,64	48,26	60,96	73,66	78,74

- 1) Contact number 1
- 2) No polarization slot for 6, 10, or 14way female connector
- 3) No polarization slot for 6way female connector
- 4) 6way: 2.0 mm

For Performance Level 3 please specify digit 7 *
 For Performance Level 2 please specify digit 6 *
 > 0.76 μm Au (30 μ inch) on request 5 *

* Not kept in stock

SEK



Number of contacts

6-64 SEK 18
26-64 SEK 24

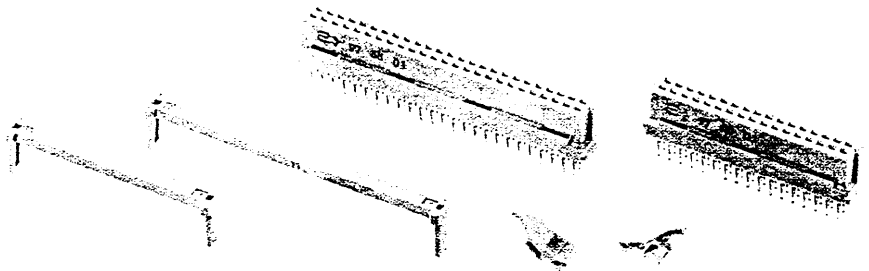

Strain relief clamp/Locking lever

Press in female connector SEK 24

Identification	No. of contacts	Part No.	Drawing	Dimensions in mm																								
Strain relief clamp	6	09 18 506 9002	<table border="1"> <thead> <tr> <th>No. of contacts</th> <th>A</th> </tr> </thead> <tbody> <tr><td>6</td><td>12.2</td></tr> <tr><td>10</td><td>17.3</td></tr> <tr><td>14</td><td>22.4</td></tr> <tr><td>16</td><td>24.9</td></tr> <tr><td>20</td><td>30.0</td></tr> <tr><td>26</td><td>37.6</td></tr> <tr><td>34</td><td>47.8</td></tr> <tr><td>40</td><td>55.4</td></tr> <tr><td>50</td><td>68.1</td></tr> <tr><td>60</td><td>80.8</td></tr> <tr><td>64</td><td>85.9</td></tr> </tbody> </table>	No. of contacts	A	6	12.2	10	17.3	14	22.4	16	24.9	20	30.0	26	37.6	34	47.8	40	55.4	50	68.1	60	80.8	64	85.9	
	No. of contacts	A																										
	6	12.2																										
	10	17.3																										
	14	22.4																										
	16	24.9																										
	20	30.0																										
	26	37.6																										
	34	47.8																										
	40	55.4																										
	50	68.1																										
	60	80.8																										
	64	85.9																										
10	09 18 510 9002																											
14	09 18 514 9002																											
16	09 18 516 9002																											
20	09 18 520 9002																											
26	09 18 526 9002																											
34	09 18 534 9002																											
40	09 18 540 9002																											
50	09 18 550 9002																											
60	09 18 560 9002																											
64	09 18 564 9002																											

Locking lever for female connector
 Only in conjunction with low-profile male header and strain relief

09 18 000 9905¹⁾

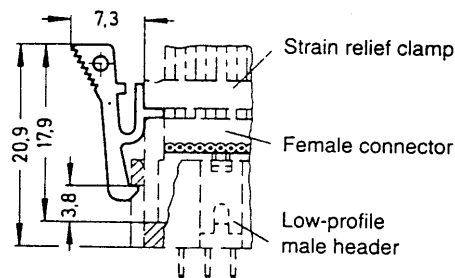

¹⁾ Order 2 per female connector

Female connector SEK 24 with straight press-in terminations and central polarization

No. of contacts	A	B
26	36.70	2.54 x 12 = 30.48
34	46.90	2.54 x 16 = 40.64
40	54.50	2.54 x 19 = 48.26
50	67.20	2.54 x 24 = 60.96
64	85.00	2.54 x 31 = 78.74

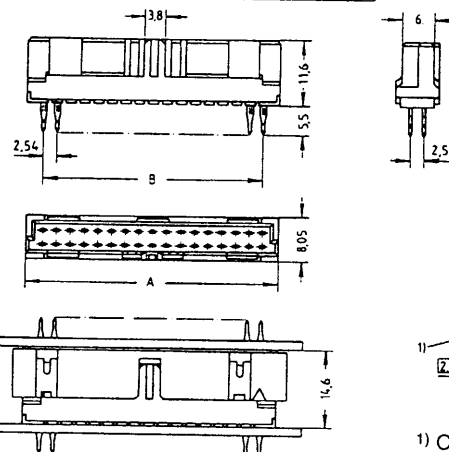

¹⁾ Contact number 1
²⁾ Pitch tolerance: ± 0.1

For Performance Level 3 please specify digit 7
 For Performance Level 2 please specify digit 6
 > 0.76 μm Au (30 μ inch) on request 5*

* Not kept in stock

For coding see page 15

Number of contacts

6-64

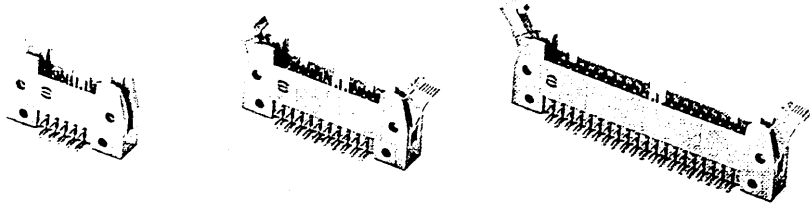

Male header with angled pins

Identification/pins

Male header with angled solder pins

Length: 2.9 mm

Male header with angled solder pins

Length: 4.5 mm

Male header with angled wrap posts

Length: 15 mm
□ 0.6 mm

No. of contacts	Part No.		
	Without levers	With short levers	With long levers
6	09 18 506 □ 923	09 18 506 □ 913	09 18 506 □ 903
10	09 18 510 □ 923	09 18 510 □ 913	09 18 510 □ 903
14	09 18 514 □ 923	09 18 514 □ 913	09 18 514 □ 903
16	09 18 516 □ 923	09 18 516 □ 913	09 18 516 □ 903
20	09 18 520 □ 923	09 18 520 □ 913	09 18 520 □ 903
26	09 18 526 □ 923	09 18 526 □ 913	09 18 526 □ 903
34	09 18 534 □ 923	09 18 534 □ 913	09 18 534 □ 903
40	09 18 540 □ 923	09 18 540 □ 913	09 18 540 □ 903
50	09 18 550 □ 923	09 18 550 □ 913	09 18 550 □ 903
60	09 18 560 □ 923	09 18 560 □ 913	09 18 560 □ 903
64	09 18 564 □ 923	09 18 564 □ 913	09 18 564 □ 903
6	09 18 506 □ 921*	09 18 506 □ 911*	09 18 506 □ 901*
10	09 18 510 □ 921*	09 18 510 □ 911*	09 18 510 □ 901*
14	09 18 514 □ 921*	09 18 514 □ 911*	09 18 514 □ 901*
16	09 18 516 □ 921*	09 18 516 □ 911*	09 18 516 □ 901*
20	09 18 520 □ 921*	09 18 520 □ 911*	09 18 520 □ 901*
26	09 18 526 □ 921*	09 18 526 □ 911*	09 18 526 □ 901*
34	09 18 534 □ 921*	09 18 534 □ 911*	09 18 534 □ 901*
40	09 18 540 □ 921*	09 18 540 □ 911*	09 18 540 □ 901*
50	09 18 550 □ 921*	09 18 550 □ 911*	09 18 550 □ 901*
60	09 18 560 □ 921*	09 18 560 □ 911*	09 18 560 □ 901*
64	09 18 564 □ 921*	09 18 564 □ 911*	09 18 564 □ 901*
6	09 18 506 □ 926*	09 18 506 □ 916*	09 18 506 □ 906*
10	09 18 510 □ 926*	09 18 510 □ 916*	09 18 510 □ 906*
14	09 18 514 □ 926*	09 18 514 □ 916*	09 18 514 □ 906*
16	09 18 516 □ 926*	09 18 516 □ 916*	09 18 516 □ 906*
20	09 18 520 □ 926*	09 18 520 □ 916*	09 18 520 □ 906*
26	09 18 526 □ 926*	09 18 526 □ 916*	09 18 526 □ 906*
34	09 18 534 □ 926*	09 18 534 □ 916*	09 18 534 □ 906*
40	09 18 540 □ 926*	09 18 540 □ 916*	09 18 540 □ 906*
50	09 18 550 □ 926*	09 18 550 □ 916*	09 18 550 □ 906*
60	09 18 560 □ 926*	09 18 560 □ 916*	09 18 560 □ 906*
64	09 18 564 □ 926*	09 18 564 □ 916*	09 18 564 □ 906*

For Performance Level 3 please specify digit 7*

For Performance Level 2 please specify digit 6*

> 0.76 μm Au (30 μ inch) on request 5*

7

6

5*

*Not kept in stock

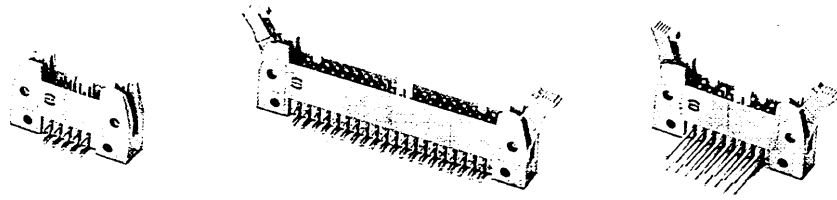

Drawing

Dimensions in mm

No. of contacts	A	B	D	E	F	G
6	26.9	16.76	12.45	2.54 x 2 = 5.08	36.9	40.3
10	32.0	21.84	17.53	2.54 x 4 = 10.16	42.0	45.4
14	37.1	26.92	22.61	2.54 x 6 = 15.24	47.1	50.4
16	39.6	29.46	25.15	2.54 x 7 = 17.78	49.6	53.0
20	44.7	34.54	30.23	2.54 x 9 = 22.86	54.7	58.1
26	52.3	42.16	37.85	2.54 x 12 = 30.48	62.3	65.7
34	62.5	52.32	48.01	2.54 x 16 = 40.64	72.5	75.8
40	70.1	59.94	55.63	2.54 x 19 = 48.26	80.1	83.5
50	82.8	72.64	68.33	2.54 x 24 = 60.96	92.8	96.2
60	95.5	85.34	81.03	2.54 x 29 = 73.66	105.5	108.9
64	100.6	90.42	86.11	2.54 x 31 = 78.74	110.6	113.9

PC. board layout

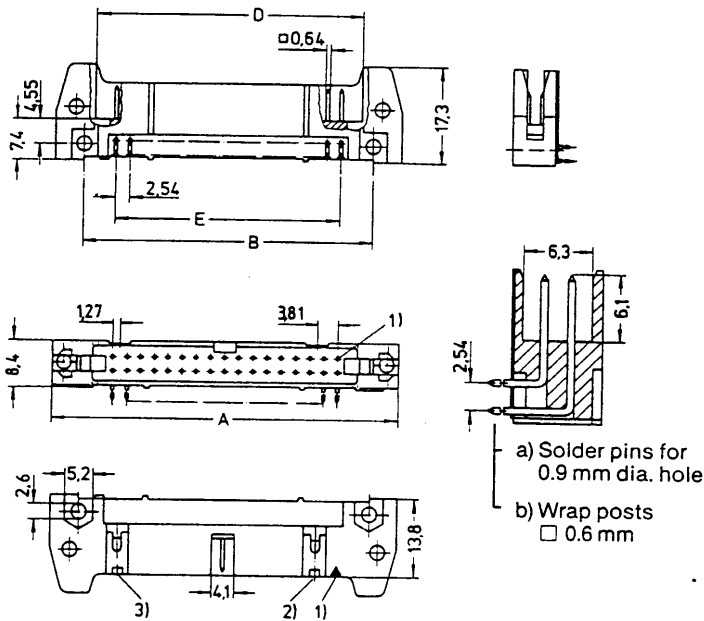
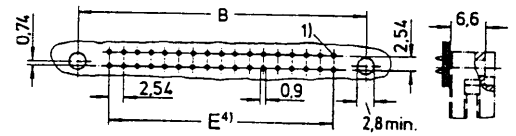

- a) Solder pins for 0.9 mm dia. hole
- b) Wrap posts □ 0.6 mm

Short levers

for use with female connector without strain relief clamp

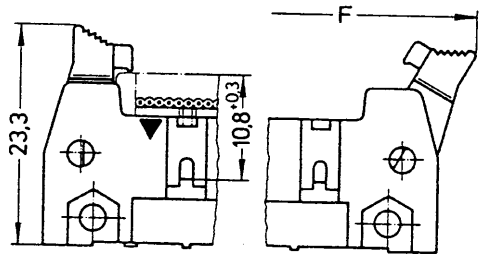

Long levers

for use with female connector with strain relief clamp

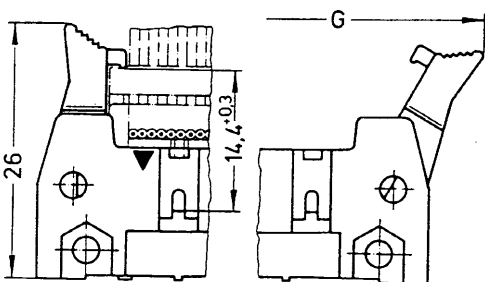

- 1) Contact number 1
- 2) No polarization slot for 6, 10, or 14 way male header
- 3) No polarization slot for 6 way male header
- 4) Pitch tolerance: ± 0.1



Number of contacts

6-64

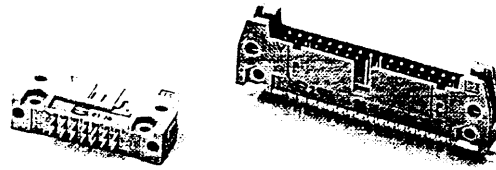

Male header with straight pins

Identification/pins

Male header with straight solder pins

Length: 2.9 mm

Male header with straight solder pins

Length: 4.5 mm

Male header with straight wrap posts

Length: 15 mm

□ 0.6 mm

No. of contacts	Part No.		
	Without levers	With short levers	With long levers
6	09 18 506 □ 924	09 18 506 □ 914	09 18 506 □ 904
10	09 18 510 □ 924	09 18 510 □ 914	09 18 510 □ 904
14	09 18 514 □ 924	09 18 514 □ 914	09 18 514 □ 904
16	09 18 516 □ 924	09 18 516 □ 914	09 18 516 □ 904
20	09 18 520 □ 924	09 18 520 □ 914	09 18 520 □ 904
26	09 18 526 □ 924	09 18 526 □ 914	09 18 526 □ 904
34	09 18 534 □ 924	09 18 534 □ 914	09 18 534 □ 904
40	09 18 540 □ 924	09 18 540 □ 914	09 18 540 □ 904
50	09 18 550 □ 924	09 18 550 □ 914	09 18 550 □ 904
60	09 18 560 □ 924	09 18 560 □ 914	09 18 560 □ 904
64	09 18 564 □ 924	09 18 564 □ 914	09 18 564 □ 904
6	09 18 506 □ 922*	09 18 506 □ 912*	09 18 506 □ 902*
10	09 18 510 □ 922*	09 18 510 □ 912*	09 18 510 □ 902*
14	09 18 514 □ 922*	09 18 514 □ 912*	09 18 514 □ 902*
16	09 18 516 □ 922*	09 18 516 □ 912*	09 18 516 □ 902*
20	09 18 520 □ 922*	09 18 520 □ 912*	09 18 520 □ 902*
26	09 18 526 □ 922*	09 18 526 □ 912*	09 18 526 □ 902*
34	09 18 534 □ 922*	09 18 534 □ 912*	09 18 534 □ 902*
40	09 18 540 □ 922*	09 18 540 □ 912*	09 18 540 □ 902*
50	09 18 550 □ 922*	09 18 550 □ 912*	09 18 550 □ 902*
60	09 18 560 □ 922*	09 18 560 □ 912*	09 18 560 □ 902*
64	09 18 564 □ 922*	09 18 564 □ 912*	09 18 564 □ 902*
6	09 18 506 □ 927*	09 18 506 □ 917*	09 18 506 □ 907*
10	09 18 510 □ 927*	09 18 510 □ 917*	09 18 510 □ 907*
14	09 18 514 □ 927*	09 18 514 □ 917*	09 18 514 □ 907*
16	09 18 516 □ 927*	09 18 516 □ 917*	09 18 516 □ 907*
20	09 18 520 □ 927*	09 18 520 □ 917*	09 18 520 □ 907*
26	09 18 526 □ 927*	09 18 526 □ 917*	09 18 526 □ 907*
34	09 18 534 □ 927*	09 18 534 □ 917*	09 18 534 □ 907*
40	09 18 540 □ 927*	09 18 540 □ 917*	09 18 540 □ 907*
50	09 18 550 □ 927*	09 18 550 □ 917*	09 18 550 □ 907*
60	09 18 560 □ 927*	09 18 560 □ 917*	09 18 560 □ 907*
64	09 18 564 □ 927*	09 18 564 □ 917*	09 18 564 □ 907*

For Performance Level 3 please specify digit 7*

For Performance Level 2 please specify digit 6*

> 0.76 μm Au (30 μ inch) on request 5*

7

6

5*

7

6

5*

*Not kept in stock

SEK 18 DIN 41 651

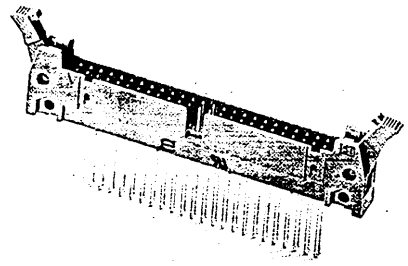
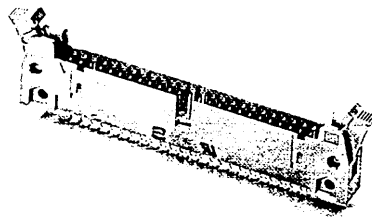

Drawing

No. of contacts	A	C	D	E	F	G
6	26.9	22.86	12.45	2.54x 2 = 5.08	36.9	40.3
10	32.0	27.94	17.53	2.54x 4 = 10.16	42.0	45.4
14	37.1	33.02	22.61	2.54x 6 = 15.24	47.1	50.4
16	39.6	35.56	25.15	2.54x 7 = 17.78	49.6	53.0
20	44.7	40.64	30.23	2.54x 9 = 22.86	54.7	58.1
26	52.3	48.26	37.85	2.54x12 = 30.48	62.3	65.7
34	62.5	58.42	48.01	2.54x16 = 40.64	72.5	75.8
40	70.1	66.04	55.63	2.54x19 = 48.26	80.1	83.5
50	82.8	78.74	68.33	2.54x24 = 60.96	92.8	96.2
60	95.5	91.44	81.03	2.54x29 = 73.66	105.5	108.9
64	100.6	96.52	86.11	2.54x31 = 78.74	110.6	113.9

Dimensions in mm

PC. board layout

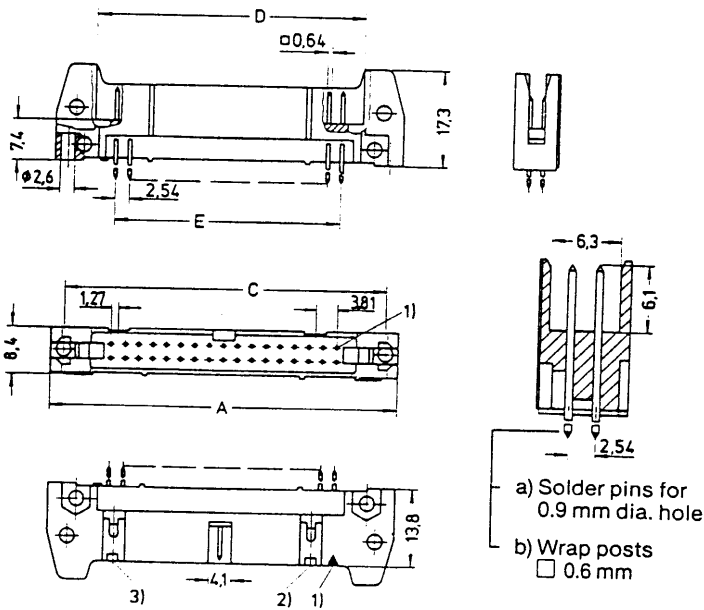
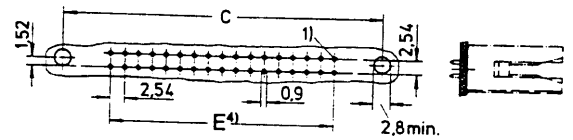

Short levers

for use with female connector without strain relief clamp

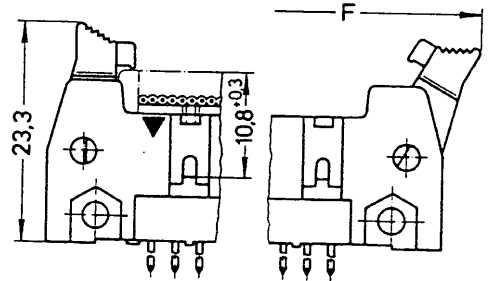

Long levers

for use with female connector with strain relief clamp

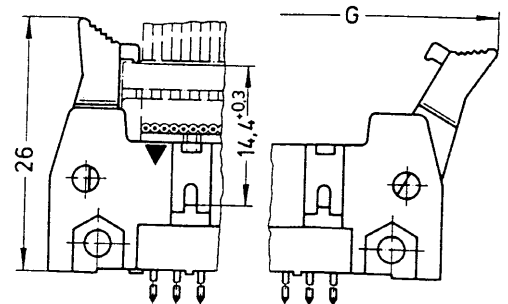

- 1) Contact number 1
- 2) No polarization slot for 6, 10, or 14 way male header
- 3) No polarization slot for 6 way male header
- 4) Pitch tolerance: ± 0.1

For accessories see page 15

SEK 18

864 780
864 766
864-791.
864-821



Number of contacts

6-64

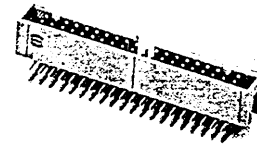

Low-profile male header, angled pins

Identification/pins	No. of contacts	Part No.	Drawing	Dimensions in mm			
				No. of contacts	A	B	E
Male header with angled solder pins Length: 2.9 mm	6	09 18 506	323	6	15.2	12.78	2.54 x 2 = 5.08
	10	09 18 510	323	10	20.3	17.86	2.54 x 4 = 10.16
	14	09 18 514	323	14	25.4	22.94	2.54 x 6 = 15.24
	16	09 18 516	323	16	27.9	25.48	2.54 x 7 = 17.78
	20	09 18 520	323	20	33.0	30.56	2.54 x 9 = 22.86
	26	09 18 526	323	26	40.6	38.18	2.54 x 12 = 30.48
	34	09 18 534	323	34	50.8	48.34	2.54 x 16 = 40.64
	40	09 18 540	323	40	58.4	55.96	2.54 x 19 = 48.26
	50	09 18 550	323	50	71.3	68.66	2.54 x 24 = 60.96
	60	09 18 560	323	60	84.0	81.36	2.54 x 29 = 73.66
	64	09 18 564	323	64	89.1	86.44	2.54 x 31 = 78.74

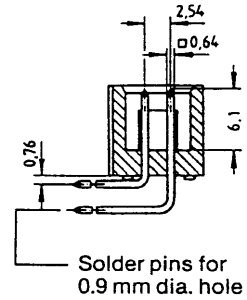

Male header with angled solder pins
Length: 4.5 mm

6	09 18 506	321*
10	09 18 510	321*
14	09 18 514	321*
16	09 18 516	321*
20	09 18 520	321*
26	09 18 526	321*
34	09 18 534	321*
40	09 18 540	321*
50	09 18 550	321*
60	09 18 560	321*
64	09 18 564	321*

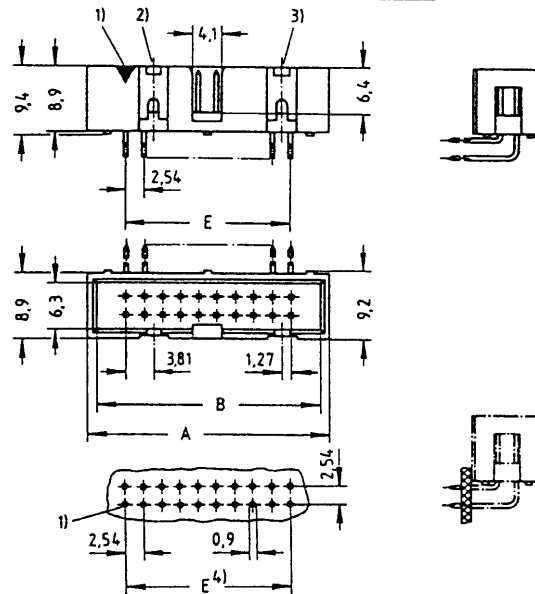

- 1) Contact number 1
- 2) No polarization slot for 6, 10, or 14 way male header
- 3) No polarization slot for 6 way male header
- 4) Pitch tolerance: ± 0.1

Male header with angled solder pins for prelocking on P.C.B 1.6 mm

on request

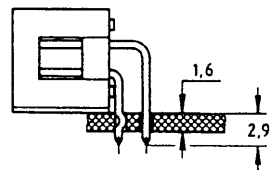

Length: 2.9 mm

max. 6 specially formed soldered pins provide retention of the male header before soldering process

864-754

SEK 18

Number of contacts

6-64

Low-profile male header, straight pins

Identification/pins
Male header with
straight solder pins

Length: 2.9 mm

No. of
contacts

- 6
- 10
- 14
- 16
- 20
- 26
- 34
- 40
- 50
- 60
- 64

Part No.

- 09 18 506 L 324
- 09 18 510 L 324
- 09 18 514 L 324
- 09 18 516 L 324
- 09 18 520 L 324
- 09 18 526 L 324
- 09 18 534 L 324
- 09 18 540 L 324
- 09 18 550 L 324
- 09 18 560 L 324
- 09 18 564 L 324

Drawing

No. of contacts	A	B	E
6	15.2	12.78	2.54 x 2 = 5.08
10	20.3	17.86	2.54 x 4 = 10.16
14	25.4	22.94	2.54 x 6 = 15.24
16	27.9	25.48	2.54 x 7 = 17.78
20	33.0	30.56	2.54 x 9 = 22.86
26	40.6	38.18	2.54 x 12 = 30.48
34	50.8	48.34	2.54 x 16 = 40.64
40	58.4	55.96	2.54 x 19 = 48.26
50	71.3	68.66	2.54 x 24 = 60.96
60	84.0	81.36	2.54 x 29 = 73.66
64	89.1	86.44	2.54 x 31 = 78.74

Dimensions in mm

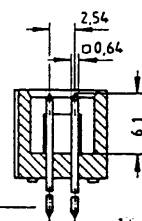

a) Solder pins for 0.9 mm dia. hole

b) Press-in pins for 1.0 mm dia. hole

Male header with
straight solder pins

Length: 4.5 mm

- 6
- 10
- 14
- 16
- 20
- 26
- 34
- 40
- 50
- 60
- 64

- 09 18 506 L 322*
- 09 18 510 L 322*
- 09 18 514 L 322*
- 09 18 516 L 322*
- 09 18 520 L 322*
- 09 18 526 L 322*
- 09 18 534 L 322*
- 09 18 540 L 322*
- 09 18 550 L 322*
- 09 18 560 L 322*
- 09 18 564 L 322*

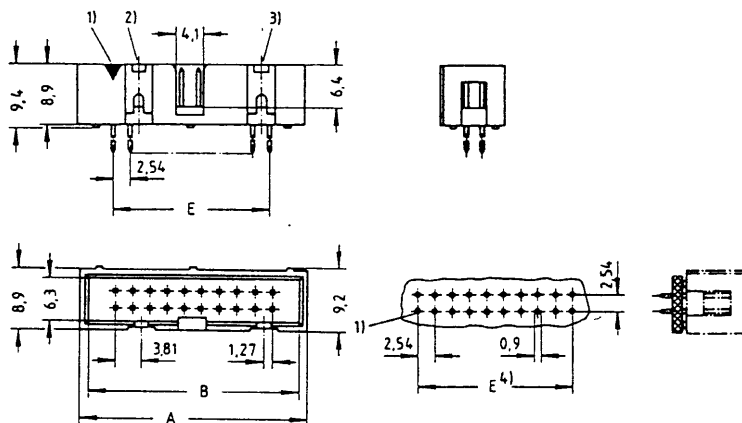

Male header with
straight press-in
terminations

Length: 5.5 mm

- 6
- 10
- 14
- 16
- 20
- 26
- 34
- 40
- 50
- 60
- 64

- 09 18 506 L 329
- 09 18 510 L 329
- 09 18 514 L 329
- 09 18 516 L 329
- 09 18 520 L 329
- 09 18 526 L 329
- 09 18 534 L 329
- 09 18 540 L 329
- 09 18 550 L 329
- 09 18 560 L 329
- 09 18 564 L 329

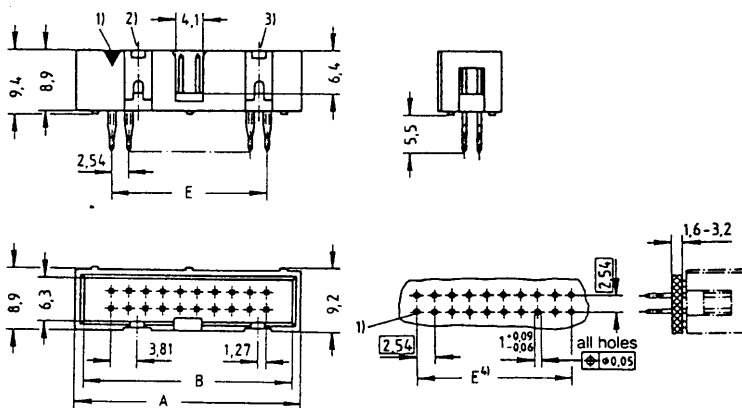

- 1) Contact number 1
- 2) No polarization slot for 6, 10, or 14 way male header
- 3) No polarization slot for 6 way male header
- 4) Pitch tolerance: ± 0.1

Tools page 14

For Performance Level 3 please specify digit 7
 For Performance Level 2 please specify digit 6
 > 0.76 μm Au (30 μ inch) on request 5*

*Not kept in stock

For accessories see page 15

Tools for press-in technique



Identification Part No. Drawing Dimensions in mm

Hand bench press 09 99 000 0201

Pneumatic press 09 99 000 0258

Base plate 09 99 000 0255

Bottom tool
narrow 09 99 000 0256

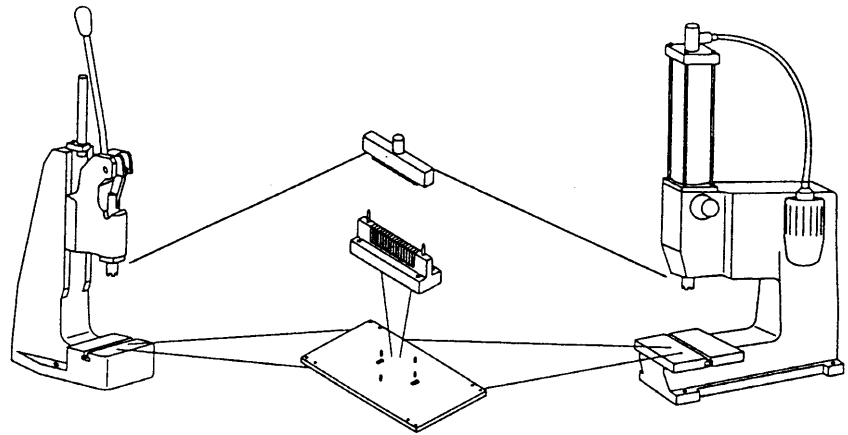

Tools

for male connectors	6	09 99 000 0 06
	10	09 99 000 0 10
	14	09 99 000 0 14
	16	09 99 000 0 16
	20	09 99 000 0 20
	26	09 99 000 0 26
	34	09 99 000 0 34
	40	09 99 000 0 40
	50	09 99 000 0 50
	60	09 99 000 0 60
	64	09 99 000 0 64

Top Tool
including insert > 4
Modular insert > 5

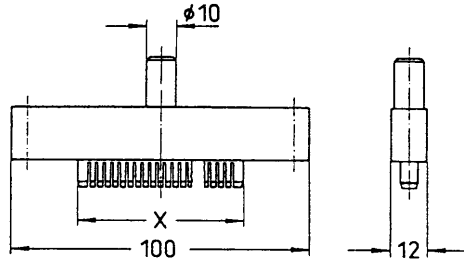

x Length depends on number of contacts

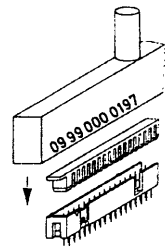
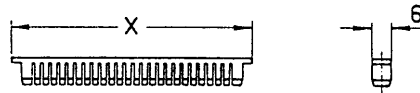

Top Tool
for SEK 24 female
connectors and male
connectors with modular
insert

09 99 000 0197

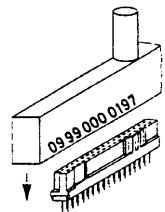
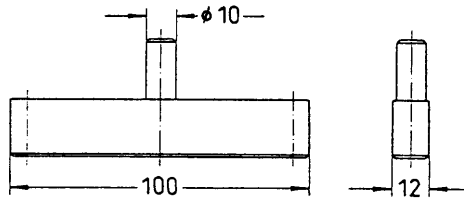

Press-out tool
for complete
male connectors

for 5.5 mm terminations 09 99 000 0220

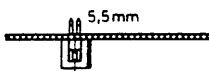
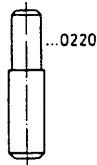

Support block 09 99 000 0218

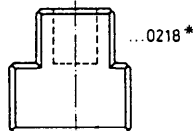

* Further versions on request

Identification Part No. Drawing Dimensions in mm

Polarization key

09 18 500 9902¹⁾

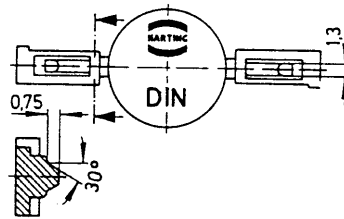

¹⁾ Part No. comprises 2 keys

Locking lever

(snaps into place, can be fitted whenever required)

Long:
09 18 000 9903²⁾

Short:
09 18 000 9904²⁾

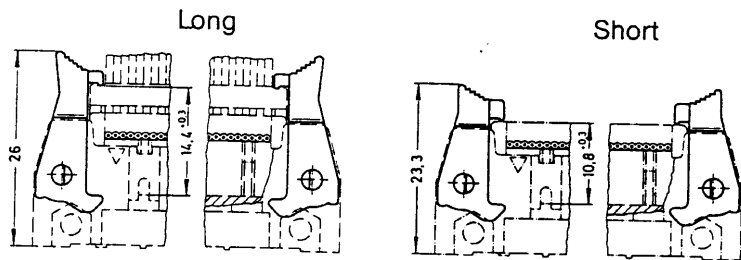

For use with female connector with strain relief clamp

For use with female connector without strain relief clamp

²⁾ Order 2 per male header

Fixing screws

for 1.6 mm PC. board

09 18 000 9906³⁾

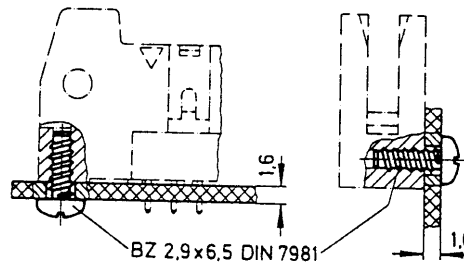

³⁾ Part No. comprises 50 pieces (Order 50 or multiples of 50)

Coding system with loss of contact

Code pin
09 18 000 9901⁴⁾

To avoid cross-plugging adjacent connectors a coding system is required. A code pin is inserted into the appropriate cavity in the female connector. The corresponding male contact is removed by a special removal tool.

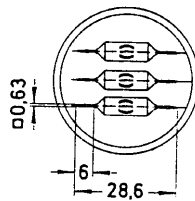

Removal tool for male contacts
09 99 000 0133



⁴⁾ Part No. comprises 6 code pins

Number of contacts

20, 34

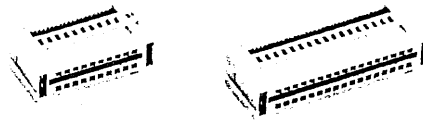

Card edge connectors for insulation displacement

Identification	Number of contacts	Part No.	Drawing	Dimensions in mm				
				No. of contacts	A	B	B ₁ ±0,1	E
Card edge connectors for insulation displacement for P.C.B. thickness 1.6 mm	20	09 18 620 — 803		20	37.30	28.20	27.80	2.54 x 9 = 22.86
	34	09 18 634 — 803		34	55.10	46	45.60	2.54 x 16 = 40.64

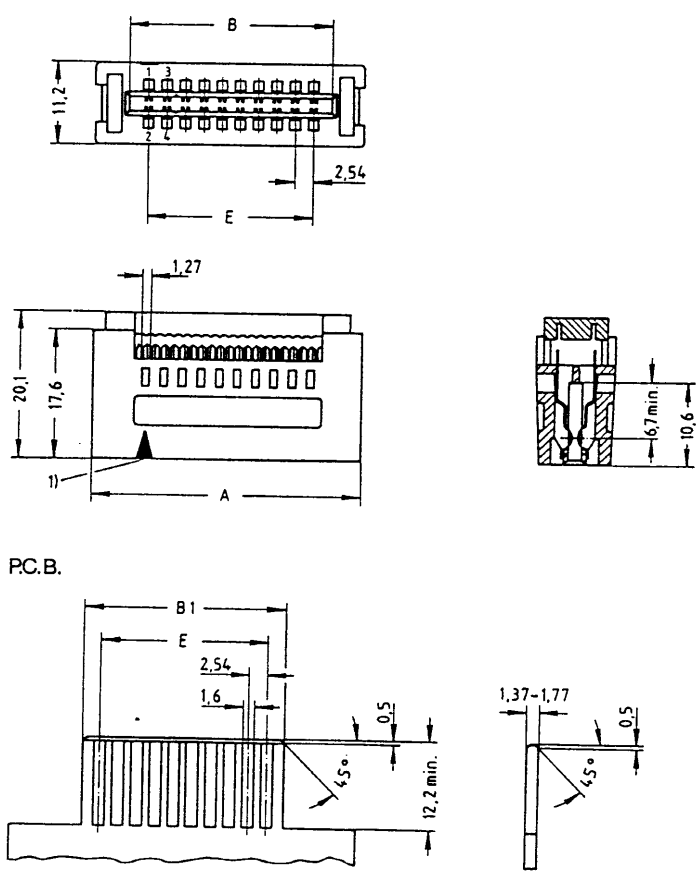

1) Contact number 1

For Performance Level 3 please specify digit 7
 > 0,76 μm Au (30 μ inch) 5

*on request

SEK 18

864900
864845
864912, 864882
864857



Number of contacts

6-64

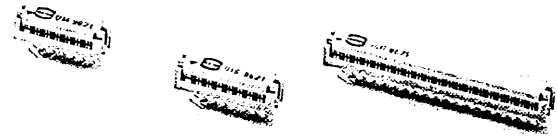

PC.B. transition connector, 2 rows

Identification	No. of contacts	Part No.	Drawing		Dimensions in mm
			No. of contacts	A	
PC.B. transition connector 2 rows	6	09 18 106 9621	6	11.9	2.54x 2 = 5.08
	10	09 18 110 9621	10	17.0	2.54x 4 = 10.16
	14	09 18 114 9621	14	22.1	2.54x 6 = 15.24
	16	09 18 116 9621	16	24.6	2.54x 7 = 17.78
	20	09 18 120 9621	20	29.7	2.54x 9 = 22.86
	26	09 18 126 9621	26	37.3	2.54x12 = 30.48
	34	09 18 134 9621	34	47.5	2.54x16 = 40.64
	40	09 18 140 9621	40	55.1	2.54x19 = 48.26
	50	09 18 150 9621	50	67.8	2.54x24 = 60.96
	60	09 18 160 9621	60	80.5	2.54x29 = 73.66
	64	09 18 164 9621	64	85.6	2.54x31 = 78.74

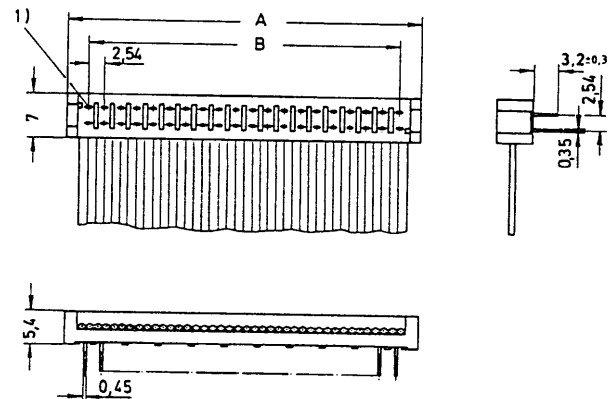

PC. board layout

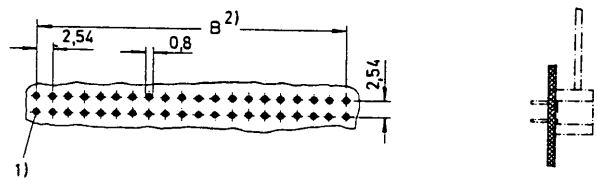

1) Lead number 1
2) Pitch tolerance: ± 0.1

Number of contacts

14-40

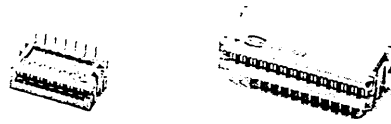

DIP connector for IC base or for soldering into P.C. boards

Identification No. of contacts Part No. Drawing Dimensions in mm

DIP connector



09 17 014 9622	14
09 17 016 9622	16
09 17 024 9622	24
09 17 028 9622	28
09 17 040 9622	40

No. of contacts	A	B	C	D
14	20.5	2.54 x 6 = 15.24	11	7.62
16	23.0	2.54 x 7 = 17.78	11	7.62
24	33.0	2.54 x 11 = 27.94	18.7	15.24
28	38.1	2.54 x 13 = 33.02	18.7	15.24
40	53.3	2.54 x 19 = 48.26	18.7	15.24

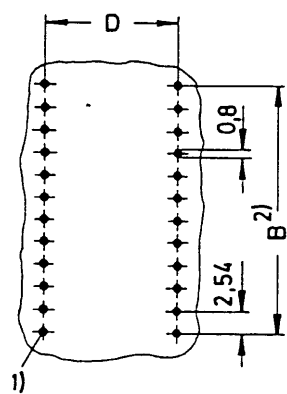
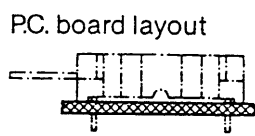
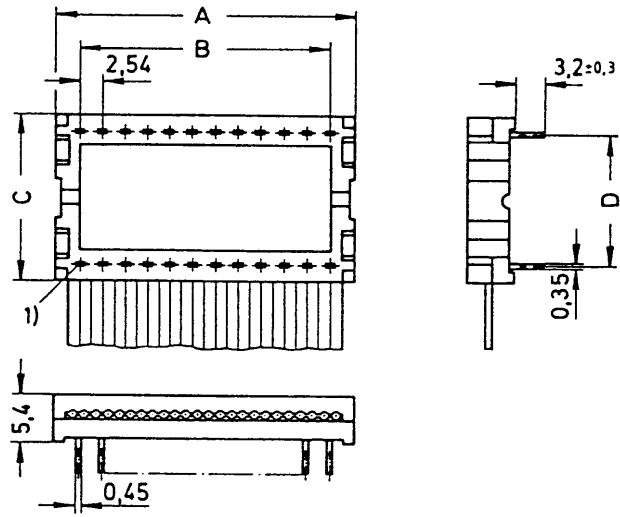

1) Lead number 1
 2) Pitch
 tolerance: ± 0.1

SEK 19



Number of contacts

10-50



PC.B. transition connector, 4 rows

Identification	No. of contacts	Part No.	Drawing	Dimensions in mm
PC.B. transition connector 4 rows	10	09 19 010 9643	No. of contacts: 10 A: 17.78 B: $1.27 \times 9 = 11.43$	
	16	09 19 016 9643	No. of contacts: 16 A: 25.40 B: $1.27 \times 15 = 19.05$	
	20	09 19 020 9643	No. of contacts: 20 A: 30.48 B: $1.27 \times 19 = 24.13$	
	26	09 19 026 9643	No. of contacts: 26 A: 38.10 B: $1.27 \times 25 = 31.75$	
	34	09 19 034 9643	No. of contacts: 34 A: 48.26 B: $1.27 \times 33 = 41.91$	
	40	09 19 040 9643	No. of contacts: 40 A: 55.88 B: $1.27 \times 39 = 49.53$	
	50	09 19 050 9643	No. of contacts: 50 A: 68.58 B: $1.27 \times 49 = 62.23$	

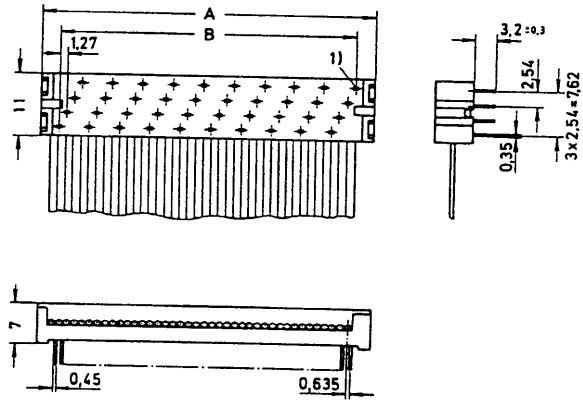

PC. board layout

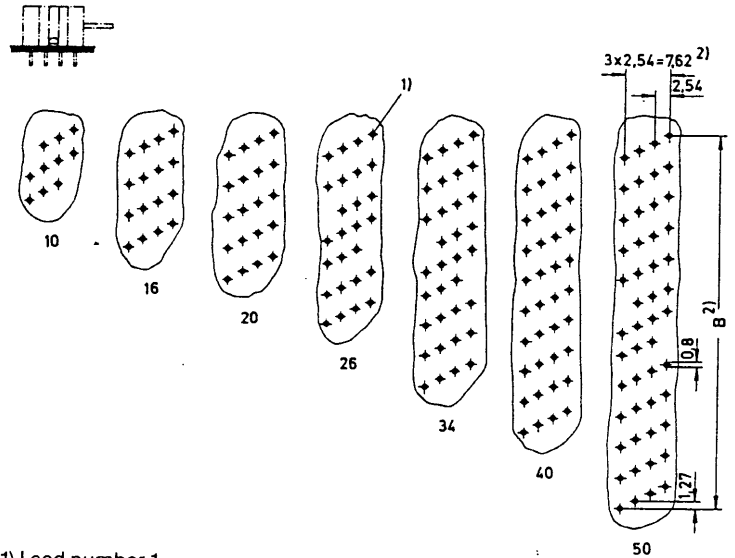

1) Lead number 1
2) Pitch tolerance: ± 0.1

Number of contacts

64



Female connectors for insulation displacement

Identification	No. of contacts	Part No.	Drawing	Dimensions in mm									
Female connector for insulation displacement													
Gds A-B	31	Performance Level 2 09 02 264 6828											
		Performance Level 3 09 02 264 7828	Lead number 1 of flat cable on contact 1 b Contact arrangement View from wiring side 										
Gds A-C	31	Performance Level 2 09 03 264 6828											
		Performance Level 3 09 03 264 7828	Lead number 1 of flat cable on contact 1 c Contact arrangement View from wiring side 										
Mateable with 3-row male connector Gds A-C. No female contact in middle row.													
Panel cut out													
<table border="1"> <thead> <tr> <th></th> <th>a</th> <th>b</th> </tr> </thead> <tbody> <tr> <td>Gds A-B</td> <td>8,3</td> <td>10,16</td> </tr> <tr> <td>Gds A-C</td> <td>10,8</td> <td>12,7</td> </tr> </tbody> </table>						a	b	Gds A-B	8,3	10,16	Gds A-C	10,8	12,7
	a	b											
Gds A-B	8,3	10,16											
Gds A-C	10,8	12,7											



Number of contacts

9-37

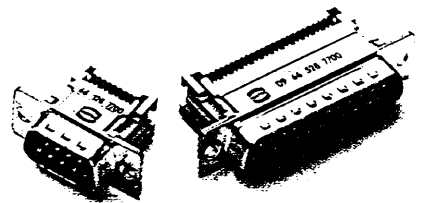
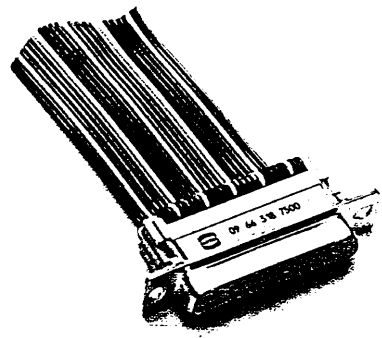

Male and female connectors

Identification	No. of contacts	Performance Level	Part No.	Performance Level
Performance Levels as per DIN 41652 Other contact surfaces on request		3		2
Male connector				
- insulation displacement termination				
pitch 1.27 mm	9	09 66 128 7700		09 66 128 6700
tinned metal shell	15	09 66 228 7700		09 66 228 6700
	25	09 66 328 7700		09 66 328 6700
	37	09 66 428 7700		09 66 428 6700
Female connector				
- insulation displacement termination				
pitch 1.27 mm	9	09 66 118 7500		09 66 118 6500
tinned metal shell	15	09 66 218 7500		09 66 218 6500
	25	09 66 318 7500		09 66 318 6500
	37	09 66 418 7500		09 66 418 6500
Strain relief clamp				
corrosion resistant steel				
for male and female connectors	9	09 66 108 0000		09 66 108 0000
	15	09 66 208 0000		09 66 208 0000
	25	09 66 308 0000		09 66 308 0000
	37	09 66 408 0000		09 66 408 0000

Dimensions

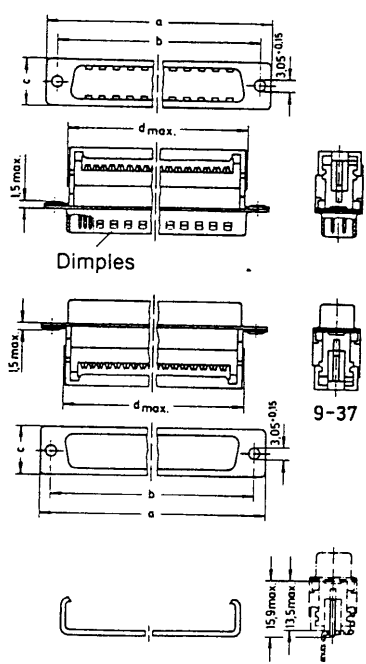

Dimensions in mm

a-0.76	b	c-0.76	d
9	31.19	25	12.93 18.6
15	39.52	33.3	12.93 26.9
25	53.42	47	12.93 40.6
37	69.7	63.5	12.93 57.1

Specified conductors
stranded wires AWG 28/7
AWG 26/7

Flat cable AWG 28/7

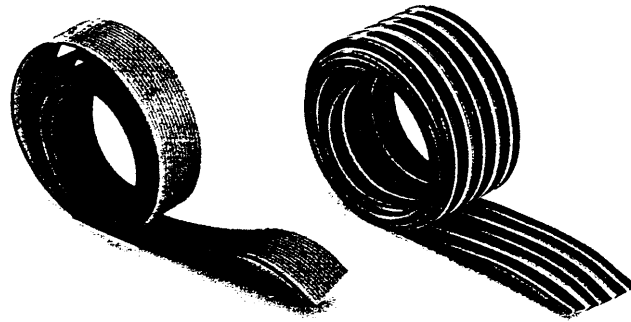

Important:
always store reels vertically.

Identification	No. of contacts	Part No.	Drawing	Dimensions in mm
Flat cable grey UL 2651 IEC 918	3 9 10 14 15 16 20 24 25 26 28 34 37 40 50 60 64	09 18 006 700 09 18 009 700 09 18 010 700 09 18 014 700 09 18 015 700 09 18 016 700 09 18 020 700 09 18 024 700 09 18 025 700 09 18 026 700 09 18 028 700 09 18 034 700 09 18 037 700 09 18 040 700 09 18 050 700 09 18 060 700 09 18 064 700		<p>NEW</p> <p>Grey 7001 = Metric packaging of 50 m</p> <p>Grey 7004 = Metric packaging of 150 m</p>
Length per reel				
50 m (164 feet) 1				
150 m (492 feet) 4				
Flat cable colour coded				
Length per reel				
30.48 m (100 feet)	10 14 15 20 24 25 26 34 37 40 50 60 64	09 18 010 7005 09 18 014 7005 09 18 016 7005 09 18 020 7005 09 18 024 7005 09 18 025 7005 09 18 026 7005 09 18 034 7005 09 18 037 7005 09 18 040 7005 09 18 050 7005 09 18 060 7005 09 18 064 7005		
UL 2884				
Wire (tinned)			Cu	
Gauge			AWG 28/7 0.089 mm ²	
Conductor resistance			230 mΩ/m	
Capacity			60 pF/m	
Characteristic impedance			110 Ω	
Signal delay			5 ns/m	
Insulation material			PVC	
Temperature rating			-20 °C + 105 °C	
Insulation resistance			10 ⁴ MΩ / km	
Wire (tinned)			Cu	
Gauge			AWG 28/7 0.089 mm ²	
Conductor resistance			230 mΩ/m	
Capacity			49 pF/m	
Characteristic impedance			105 Ω	
Signal delay			4.6 ns/m	
Insulation material			PVC	
Temperature rating			-20 °C + 105 °C	
Insulation resistance			10 ³ MΩ / km	

Flat cable AWG 28/7

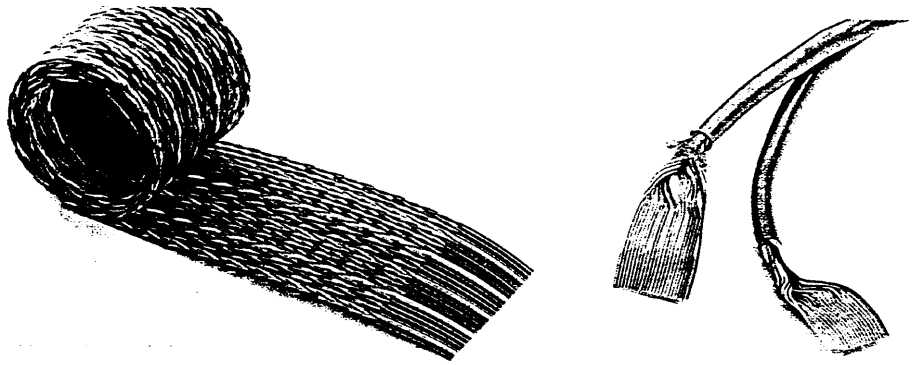

Important:
always store reels vertically.

Identification	No. of contacts	Part No.	Drawing	Dimensions in mm
Flat cable twisted pair				
Length per reel	10	09 18 010 7006		
30.48 m (100 feet)	14	09 18 014 7006		
	16	09 18 016 7006		
UL 2693	20	09 18 020 7006		
	26	09 18 026 7006		
	34	09 18 034 7006		
	40	09 18 040 7006		
	50	09 18 050 7006		
	60	09 18 060 7006		
	64	09 18 064 7006		
Round flat cable				
Length per reel				
30.48 m (100 feet)				
with screening	9	09 18 009 7007		
	10	09 18 010 7007		
UL 2464	14	09 18 014 7007		
	15	09 18 015 7007		
	16	09 18 016 7007		
	20	09 18 020 7007		
	25	09 18 025 7007		
	26	09 18 026 7007		
	34	09 18 034 7007		
	37	09 18 037 7007		
	40	09 18 040 7007		
	50	09 18 050 7007		
	60	09 18 060 7007		
	64	09 18 064 7007		
without screening	9	09 18 009 7008		
	10	09 18 010 7008		
UL 2464	14	09 18 014 7008		
	15	09 18 015 7008		
	16	09 18 016 7008		
	20	09 18 020 7008		
	25	09 18 025 7008		
	26	09 18 026 7008		
	34	09 18 034 7008		
	37	09 18 037 7008		
	40	09 18 040 7008		
	50	09 18 050 7008		
	60	09 18 060 7008		
	64	09 18 064 7008		

	Flat cable twisted pair	Round flat cable with screening	Round flat cable without screening
Wire (tinned)		Cu	
Gauge		AWG 28/7 0.089 mm ²	
Conductor resistance	230 mΩ/m	< 225 mΩ/m	
Capacity	52 pF/m	95 pF/m	65 pF/m
Characteristic impedance	100 Ω	73 Ω	90 Ω
Signal delay	5.3 ns/m	5.0 ns/m	
Insulation material	PVC	PVC	
Temperature rating	-20 °C + 105 °C	-20 °C + 80 °C	
Insulation resistance	10 ³ MΩ/km	> 50 MΩ/km	

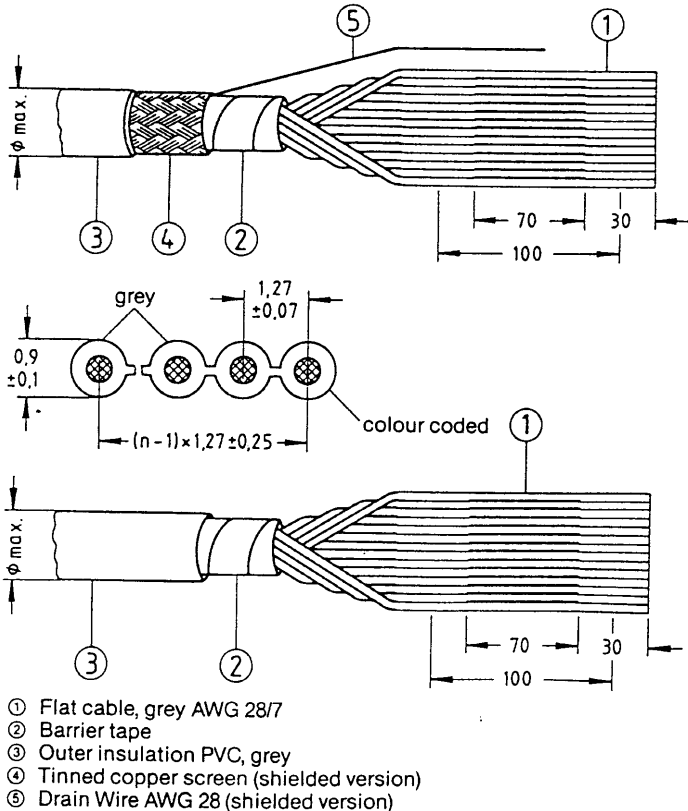

Tools for termination of flat cables



Identification

Part No.

SEK Harnessing
Work-station

on request

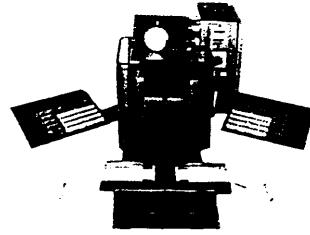

Bench press

for termination
of insulation
displacement
connectors

09 99 000 0114

Base plate
for termination
of flat cables

SEK 18	09 99 000 0115
SEK 18 Card edge	09 99 000 0268
SEK 17	09 99 000 0134
SEK 18 2 rows	09 99 000 0131
SEK 19 4 rows	09 99 000 0130
Gds A-B, Gds A-C	09 99 000 0150
D-Sub	09 99 000 0135

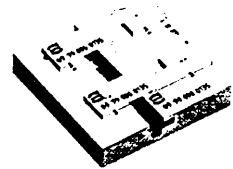
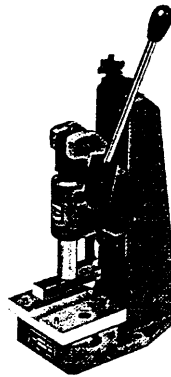

Hand tool with
base plates
(included in tool kit)
for termination
of insulation
displacement
connectors

SEK 18	09 99 000 0149
SEK 18 Card edge	
SEK 17	
SEK 18 2 rows	
Gds A-B	
Gds A-C	
D-Sub	

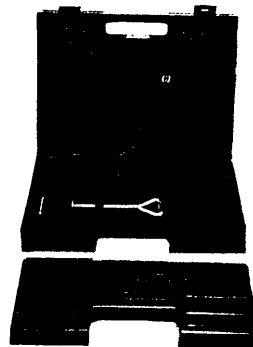

Cable cutter
for flat cables

09 99 000 0116

Spare parts

Blade

09 99 000 0179

Cutting plate

09 99 000 0180

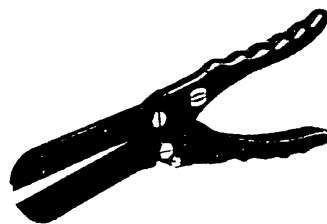

List of part numbers



Part No.	Page	Part No.	Page	Part No.	Page	Part No.	Page	Part No.	Page
09 02 264 6828	20	09 18 5	5321 * 12	09 18 5	6321 * 12	09 18 5	7321 * 12	09 24 164 5801	7
7828	20		5322 * 13		6322 * 13		7322 * 13	6801	7
09 03 264 6828	20		5323 * 12		6323 12		7323 12	7801	7
7828	20		5324 * 13		6324 13		7324 13		
			5329 * 13		6329 13		7329 13	09 66 108 0000	21
09 17 014 9622	18							118 6500	21
016 9622	18	09 18 5	5803 * 6	09 18 5	6803 6	09 18 5	7803 6	7500	21
024 9622	18		5804 * 6		6804 6		7804 * 6	128 6700 *	21
028 9622	18		5805 * 6		6805 6		7805 6	7700	21
040 9622	18		5806 * 6		6806 6		7806 * 6		
09 18 000 9901	15		5813 * 6		6813 6		7813 6	09 66 208 0000	21
9903	15		5814 * 6		6814 6		7814 * 6	218 6500	21
9904	15		5815 * 6		6815 6		7815 * 6	7500	21
9905	7		5816 * 6		6816 6		7816 * 6	228 6700	21
9906	15							7700	21
09 18 006 7001/4	22	09 18 5	5901 * 8	09 18 5	6901 * 8	09 18 5	7901 * 8	09 66 308 0000	21
009 7001/4	22		5902 * 10		6902 * 10		7902 * 10	318 6500	21
010 7001/4	22		5903 * 8		6903 8		7903 8	7500	21
014 7001/4	22		5904 * 10		6904 10		7904 10	328 6700	21
015 7001/4	22		5906 * 8		6906 * 8		7906 * 8	7700	21
016 7001/4	22		5907 * 10		6907 * 10		7907 * 10		
020 7001/4	22		5911 * 8		6911 * 8		7911 * 8	09 66 408 0000	21
024 7001/4	22		5912 * 10		6912 * 10		7912 * 10	418 6500	21
025 7001/4	22		5913 * 8		6913 8		7913 8	7500	21
026 7001/4	22		5914 * 10		6914 10		7914 10	428 6700	21
028 7001/4	22		5916 * 8		6916 * 8		7916 * 8	7700	21
034 7001/4	22		5917 * 10		6917 * 10		7917 * 10		
037 7001/4	22		5921 * 8		6921 * 8		7921 * 8	09 99 000 0114	24
040 7001/4	22		5922 * 10		6922 * 10		7922 * 10	0115	24
050 7001/4	22		5923 * 8		6923 8		7923 * 8	0116	24
060 7001/4	22		5924 * 10		6924 10		7924 * 10	0130	24
064 7001/4	22		5926 * 8		6926 * 8		7926 * 8	0131	24
			5927 * 10		6927 * 10		7927 * 10	0133	15
09 18 010 7005	22					09 18 5	9002 7	0134	24
014 7005	22							0135	24
016 7005	22							0149	24
020 7005	22							0150	24
024 7005	22							0179	24
025 7005	22							0180	24
026 7005	22								
034 7005	22							09 18 106 9621	17
037 7005	22							110 9621	17
040 7005	22							114 9621	17
050 7005	22							116 9621	17
060 7005	22							120 9621	17
064 7005	22							126 9621	17
09 18 010 7006	23							134 9621	17
014 7006	23							140 9621	17
016 7006	23							150 9621	17
020 7006	23							160 9621	17
026 7006	23							164 9621	17
034 7006	23								
040 7006	23							09 19 010 9643	19
050 7006	23							016 9643	19
060 7006	23							020 9643	19
064 7006	23							026 9643	19
								034 9643	19
								040 9643	19
								050 9643	19
								09 24 126 5801	7
								6801	7
								7801	7
								134 5801	7
								6801	7
								7801	7
								140 5801	7
								6801	7
								7801	7
								150 5801	7
								6801	7
								7801	7
								09 99 000 0506	14
								0510	14
								0514	14
								0516	14
								0520	14
								0526	14
								0534	14
								0540	14
								0550	14
								0560	14
								0564	14
09 18 500 9002	15			09 18 6	5803 16				
					7803 16				

Complete the Part No. by inserting the required number of contacts where indicated thus:

*Not kept in stock

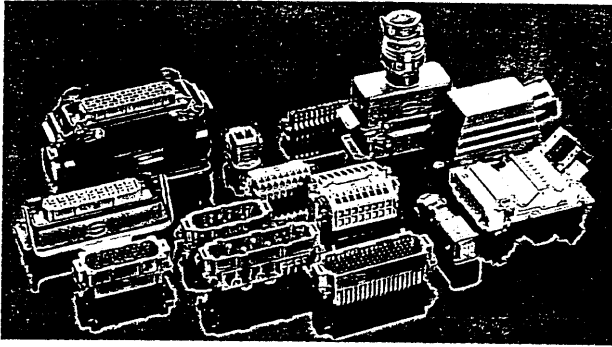

Heavy Duty Connectors
for industrial engineering

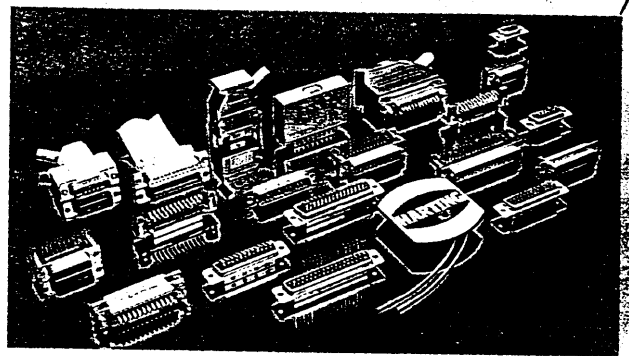

Subminiature D-Connectors
DIN 41 652

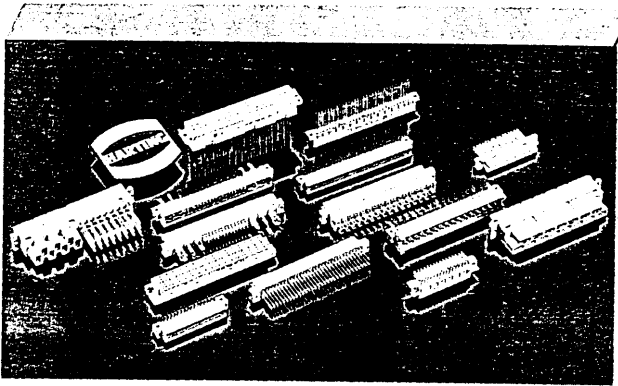

Printed Circuit Connectors
DIN 41 612 · DIN 41 617

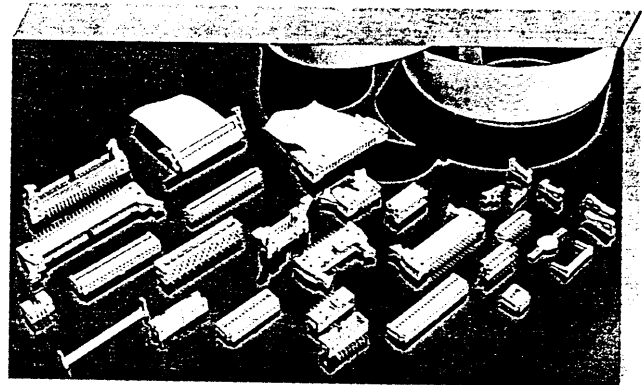

Flat Cable Connector System
DIN 41 651

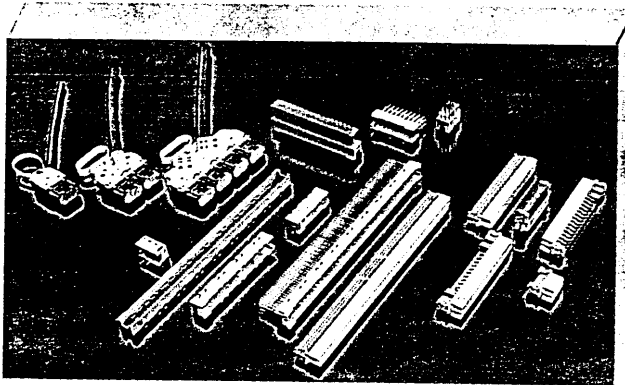

High Density Connector System
Modular · Metric · DIN 41 642

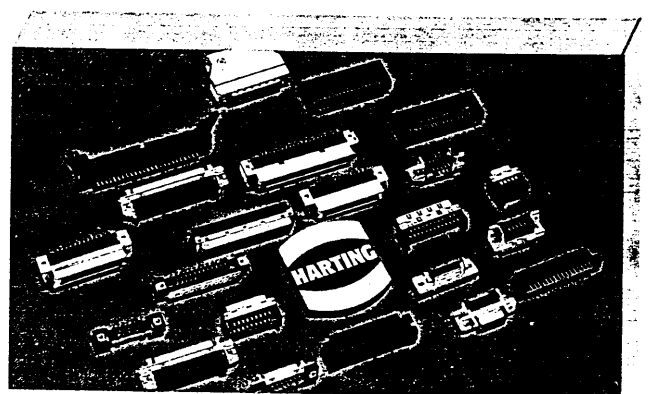

Micro-Electronic-Connectors
Contact spacing 1.27 mm

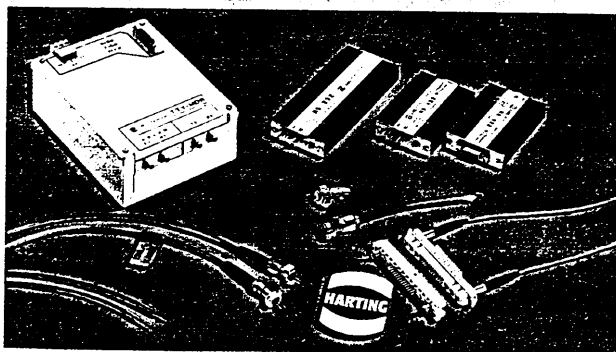

Fiber Optic Data Link
Systems and components

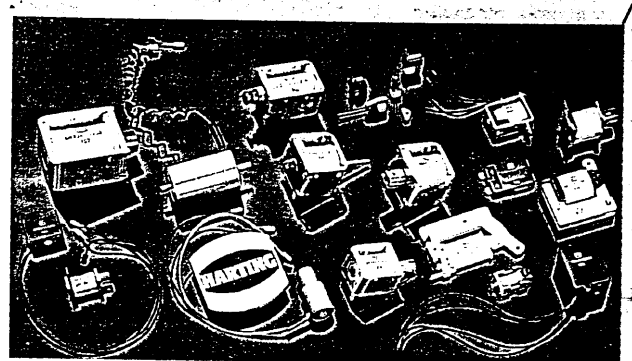

Solenoids

HARTING – branch offices in Germany

Baden-Württemberg
71640 Ludwigsburg, Voithstraße 6
Tel. (071 41) 86891, Fax (071 41) 86895

Bavarn
82152 Planegg bei München, Georgenstraße 6
Tel. (089) 856 1006, Fax (089) 8596782

90451 Nürnberg, Mülheimer Straße 15
Tel. (0911) 96355-0, Fax (0911) 6426960

Berlin – Espelkamp*

Brandenburg – Espelkamp

Bremen – Espelkamp

Hamburg – Espelkamp

Hessen – Espelkamp

Mecklenburg-Vorpommern – Espelkamp

Niedersachsen – Espelkamp

Nordrhein-Westfalen – Espelkamp

Rheinland-Pfalz/Saarland
71640 Ludwigsburg, Voithstraße 6
Tel. (071 41) 86891, Fax (071 41) 86895

Sachsen/Sachsen-Anhalt/Thüringen
09113 Chemnitz, Blankenauer Straße 99
Tel. (0371) 429211, Fax (0371) 429222

Schleswig-Holstein – Espelkamp

* Postfach 1140, 32325 Espelkamp
Tel. (057 72) 47-0, Fax (057 72) 47-461/282

Foreign representatives

Australia

Brazil
MIDES ELECTRÔNICA LTDA.
R. Christiano Otoni, 288
33600-000 - Pedro Leopoldo - MG
Tel. (031) 661-1641, Fax (031) 661-1650

Denmark

Knud Wexøe A/S
Skaettekaeret 11, P.O. Box 152
DK-2840 Holte
Tel. 42 42 32 11, Fax 42 42 34 50

Finland

SKS-teknikka Oy
Laurinmäenkuja 3, P.O. Box 40
SF-00441 Helsinki
Tel. 0-852661, Tx 124577, Fax 0-8526820

Portugal

UNIMAQUE-ELÉTRONICA E
ELECTRICIDADE INDUSTRIAL, LDA.
Rua Augusto Gil, 22-B
P-1000 Lisboa
Tel. (01) 7966732/85, Fax (01) 7960924

South-Africa

Allcable (Pty) Ltd.
P.O. Box 13518
Witfield 1467, R. S. A.
Tel. (011) 8453325, Fax (011) 8454077

Turkey

METESAN
Tünel, Ensiz Sokak Tünel Gecidi
Is Hani No. 3
Beyoglu 80050 Istanbul
Tel. (212) 2435050, Fax (212) 2490143

Production plants

Espelkamp plant 1, plant 2, plant 3
Northampton, Great Britain
Biel, Switzerland
Hong Kong

Distributors – Germany

Helmut Becker, Ing. GmbH
Elektrogroßhandel
Leipziger Straße 34, 04579 Espenhain
Tel. (034206) 74 44 37, Fax (034206) 74 35 64

elektro-bauelemente May KG
Trabener Straße 65, 14193 Berlin
Tel. (030) 8925002, Fax (030) 8919902

Hillmann & Ploog GmbH + Co KG
Ivo-Hauptmann-Ring 9, 22159 Hamburg
Tel. (040) 64588-0, Tx 215183
Fax (040) 64588440

EVN

Elektro-Vertrieb-Nord GmbH
Industriestraße 30, 24536 Neumünster
Tel. (04321) 954-221, Fax (04321) 954-229

straschu Industrie Elektronik GmbH
Mackenstedter Straße 11
28816 Stuhr/Groß Mackenstedt
Tel. (04206) 41 71-0
Fax (04206) 41 71-50

setron-Schiffer-Elektronik GmbH & Co KG
Friedrich-Seele-Straße 3a,
38122 Braunschweig
Tel. (0531) 8098-0, Tx 952812
Fax (0531) 8098-789, Teletex 5318307

EVG-Martens GmbH & Co KG
Trompeterallee 244, 41189 Mönchengladbach
Tel. (021 66) 5508-0, Tx 852275
Fax (021 66) 550890

RTG-Elektronik GmbH
Oberste-Wilms-Straße 27, 44309 Dortmund
Tel. (0231) 562073-0
Fax (0231) 562073-26

REPRO ELEKTRONIK GmbH
Obere Zeil 4, 61440 Oberursel
Tel. (061 71) 63070, Tx 410836
Fax (061 71) 630763

Peter Seiwert GmbH
Heusweiler Straße 92,
66557 Illingen-Uchtelfangen
Tel. (06825) 408-0, Tx 444102
Fax (06825) 408-40/-41

HTF elektro GmbH
Mallastraße 76 (Gewerbegebiet Mallau)
68219 Mannheim
Tel. (0621) 8776-0, Fax (0621) 8776-100

Farnell Electronic GmbH
Bahnhofstraße 44, 71696 Möglingen
Tel. (071 41) 487-0, Tx 7264472
Fax (071 41) 487-210

Emil Ratz GmbH
Kelterstraße 15-17, 75179 Pforzheim
Tel. (07231) 3708-0, Tx 783469
Fax (07231) 370899

Eckert & Graf GmbH
Zollstraße 7, 78239 Rielasingen
Tel. (07731) 59070, Tx 793848
Fax (07731) 22673

Findler & Sohn
Schwanthalerstraße 25, 80336 München
Tel. (089) 551801-0, Teletex 17 897 575

A. Schweiger GmbH
Klausnerring 20, 85551 Heimstetten
Tel. (089) 905003-0, Fax (089) 9037466

Farnell Electronic Components GmbH
Grünwalder Weg 30, 82041 Deisenhofen
Tel. (089) 6130301, Fax (089) 61303119

Falkenberg Sensortechnik GmbH
Boxdorfer Straße 11, 90765 Fürth
Tel. (0911) 930620, Fax (0911) 9306233

HARTING-Subsidiary companies

Austria
HARTING
elektronische Bauelemente Ges. m.b.H.
Himbergerstraße 25, A-1100 Wien
Tel. (1) 6868 18 + 19, Tx (61) 3222690,
Fax (1) 686903

Belgium

N. V. HARTING Elektronik S. A.
Doornveld 8, B-1731 Zellik
Tel. 02-4660190, Tx 64573, Fax 02-4667855

Czech Republic

HARTING Elektronik spol. s r. o.
Poděbradská 186/56, 18066 Praha 9
Tel. (02) 66107-475/-483, Fax (02) 862047

France

HARTING Elektronik France E.U.R.L.
ZAC Paris Nord II, 181, av. des Nations
B.P. 60058
F-95972 Roissy Charles de Gaulle Cedex
Tel. (1) 49383400, Tx 231.610,
Fax (1) 48632306

Great Britain

HARTING Elektronik Ltd.
Caswell Road, Brackmills Industrial Estate
GB-Northampton, NN 47 PW
Tel. (01604) 766686, Fax (01604) 706777

Hong Kong

HARTING Elektronik (HK) Ltd.
9th Floor, Chung Shun Knitting Centre 1-3
Wing Yip Street, Kwai Chung N.T., Hongkong
Tel. 0852-2422 1809, Fax 0852-24804378

Italy

HARTING Elektronik SpA
Via Dell' Industria 7,
I-20090 Vimodrone (Milano)
Tel. (02) 27400300, Fax (02) 2650534

Japan

HARTING Elektronik Co., Ltd.
5F German Industry Center 407
18-2, Hakusan 1-Chome, Midori-ku
Yokohama 226 Japan
Tel. (045) 931-5715, Fax (045) 931-5719

Netherlands

HARTING Elektronik B.V.
Larenweg 44, NL-5234 KA's-Hertogenbosch
Postbus 3526, NL-5203 DM's-Hertogenbosch
Tel. (073) 410404, Fax (073) 440699

Norway

HARTING Elektronik A/S
Østensjøveien 36, N-0667 Oslo
Tel. 22-64 75 90, Tx 76399, Fax 22-64 73 93

Russia

196105 St. Petersburg, a/ja 719
AO HARTING Elektronik
Tel. (812) 2948958, Fax (812) 2946572

Spain

HARTING Elektronik S.A.
Josep Tarradellas 20-30 4^aª,
E-08029 Barcelona
Tel. 3-419 28 38, Fax 3-419 95 85

Sweden

HARTING Elektronik AB
Fagerstagatan 3, S-16353 Spånga
Tel. (08) 7617980, Tx 8125158,
Fax (08) 364442

Switzerland

HARTING Elektronik AG
Industriestrasse 26, CH-8604 Volketswil
Tel. 01-9460966, Fax 01-9460970

USA

HARTING Elektronik Inc.
2155 Stonington Ave., Suite 212,
P.O. Box 95710
Hoffman Estates, Illinois 60195-0710
Tel. (708) 519-7700, Fax (708) 519-9771

East-Europe

HARTING Elektronik Bauelemente GmbH
Tiertgartenstraße 94, D-01219 Dresden
Tel. (0351) 2328457/58, Fax (0351) 2328458

South-East-Europe and other foreign countries
HARTING Elektronik GmbH
Postfach 1140, D-32325 Espelkamp